

SL

KSL8/KSL12
Manual 1.2 en

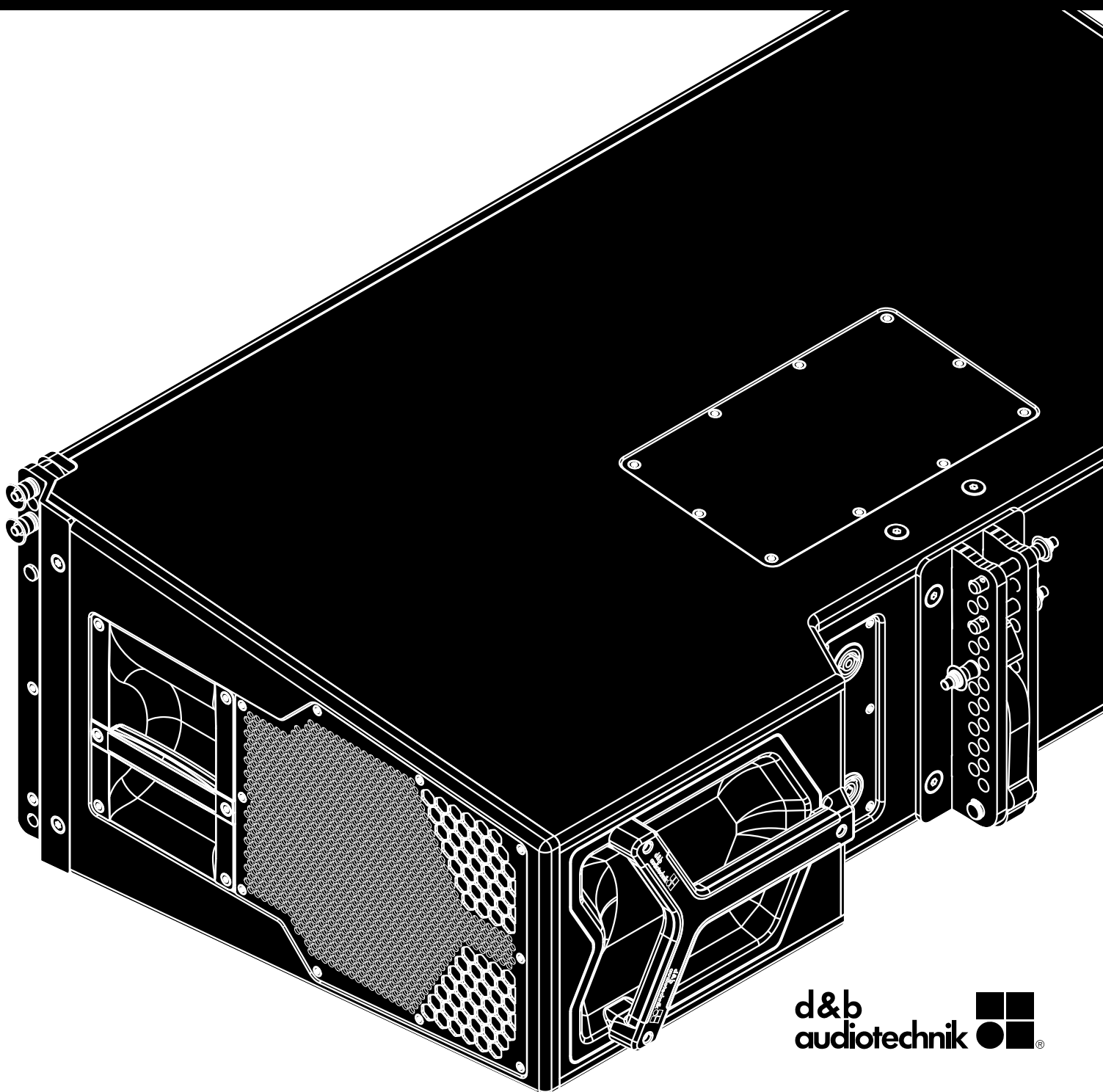

General information

KSL8/KSL12 Manual

Version: 1.2 en, 01/2020, D2732.EN .01

Copyright © 2020 by d&b audiotechnik GmbH & Co. KG; all rights reserved.

Keep this document with the product or in a safe place so that it is available for future reference.

We recommend you to regularly check the d&b website for the latest version of this document.

When reselling this product, hand over this document to the new owner.

If you supply d&b products, please draw the attention of your customers to this document. Enclose the relevant documents with the systems. If you require additional documents for this purpose, you can order them from d&b.

d&b audiotechnik GmbH & Co. KG
Eugen-Adolf-Str. 134, D-71522 Backnang, Germany
T +49-7191-9669-0, F +49-7191-95 00 00

1	Safety precautions	4
1.1	Information regarding the use of loudspeakers.....	4
1.2	d&b ArrayCalc.....	5
2	KSL8/KSL12 loudspeaker	6
2.1	Intended use.....	6
2.2	Connections.....	7
2.3	Operation.....	7
2.3.1	Controller settings.....	8
2.4	Dispersion characteristics.....	9
2.5	Technical specifications.....	10
3	Manufacturer's declarations	12
3.1	EU conformity of loudspeakers (CE symbol).....	12
3.2	WEEE Declaration (Disposal).....	12

1.1 Information regarding the use of loudspeakers

Potential risk of personal injury

Never stand in the immediate vicinity of loudspeakers driven at a high level. Professional loudspeaker systems are capable of causing a sound pressure level detrimental to human health. Seemingly non-critical sound levels (from approx. 95 dB SPL) can cause hearing damage if people are exposed to it over a long period.

In order to prevent accidents when deploying loudspeakers on the ground or when flown, please take note of the following:

- When setting up the loudspeakers or loudspeaker stands, make sure they are standing on a firm surface. If you place several systems on top of one another, use straps to secure them against movement.
- Only use accessories which have been tested and approved by d&b for assembly and mobile deployment. Pay attention to the correct application and maximum load capacity of the accessories as detailed in our specific "Mounting instructions" or in our "Flying system and Rigging manuals".
- Ensure that all additional hardware, fixings and fasteners used for installation or mobile deployment are of an appropriate size and load safety factor. Pay attention to the manufacturers' instructions and to the relevant safety guidelines.
- Regularly check the loudspeaker housings and accessories for visible signs of wear and tear, and replace them when necessary.
- Regularly check all load bearing bolts in the mounting devices.

Potential risk of material damage

Loudspeakers produce a static magnetic field even if they are not connected or are not in use. Therefore make sure when erecting and transporting loudspeakers that they are nowhere near equipment and objects which may be impaired or damaged by an external magnetic field. Generally speaking, a distance of 0.5 m (1.5 ft) from magnetic data carriers (floppy disks, audio and video tapes, bank cards, etc.) is sufficient; a distance of more than 1 m (3 ft) may be necessary with computer and video monitors.

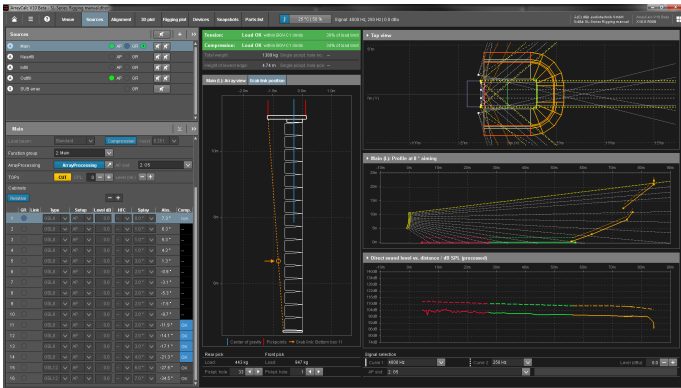

d&b ArrayCalc

1.2 d&b ArrayCalc

For both safety and acoustic reasons, d&b line arrays must be designed using the d&b ArrayCalc simulation software. The software is available as a native stand-alone application for both Microsoft Windows and Mac OS X operating systems and can be downloaded at www.dbaudio.com.

Detailed information on how to use and operate ArrayCalc is provided by the Help system of the software. To access the Help system, press F1 or select the Help button () from the ArrayCalc toolbar. This will launch the HelpViewer which provides an overview of the program as well as a search function and direct access to the related topics.

In addition, ArrayCalc will provide you with typical array configurations within the permitted load limits and will help you get familiar with the mechanical load conditions and limitations.

d&b TI 385

Further information on line array design can be found in "TI 385 d&b Line array design, ArrayCalc". The TI is supplied with the software or can be downloaded from the d&b website at www.dbaudio.com.

d&b Seminar

We also recommend you to attend the regularly hosted d&b Line array training seminars. Further information regarding the d&b seminars and a seminar schedule can also be found on the d&b website at www.dbaudio.com.

d&b Video tutorials

In addition d&b provides related video tutorials which can also be found on the d&b website at www.dbaudio.com or www.sl-series.com.

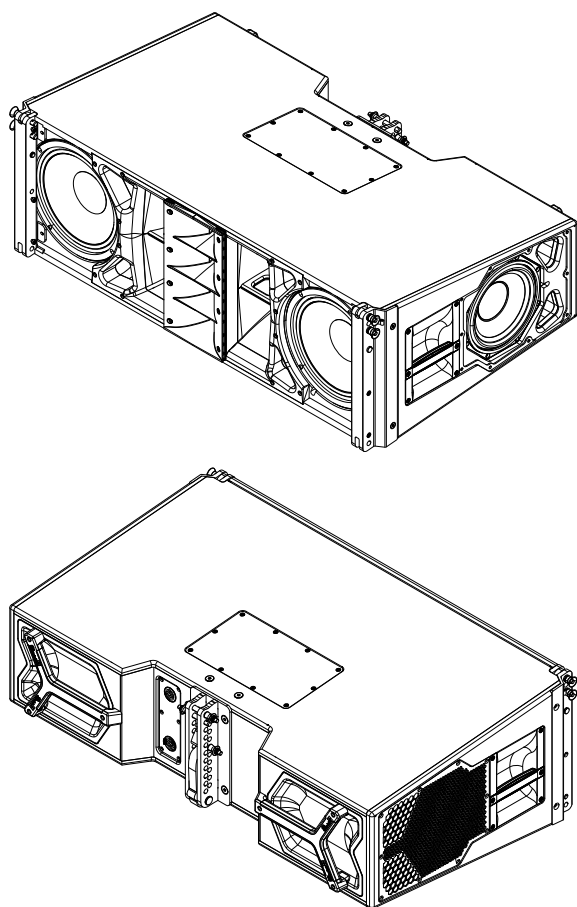

2.1 Intended use

NOTICE!

Only operate d&b SL-Series loudspeakers with the specified and correctly configured d&b amplifiers, otherwise there is a risk of damaging the loudspeaker components and the directional characteristics of the system cannot be achieved.

Applicable d&b amplifiers: D80

Product description

The KSL8 is a line array loudspeaker for medium to large-scale sound reinforcement applications. It also serves as partner to the GSL system for fill and/or delay purposes.

When the KSL Flying frame is used, up to 24 KSL8 cabinets can be flown in vertical columns producing a 80° constant directivity dispersion pattern in the horizontal plane.

The KSL12 line array loudspeaker is acoustically and mechanically compatible with the KSL8 and provides a 120° horizontal dispersion.

The KSL8/KSL12 cabinets are 3-way designs, both housing 2 x 10" neodymium forward LF drivers, 2 x 8" neodymium side firing LF drivers, one horn-loaded 8" MF driver and 2 x 1.4" exit HF compression drivers with 3" coils mounted to a dedicated wave shaping device. The cylindrical wave segments of each cabinet couple without gaps and sum up coherently. Splay angles between adjacent cabinets can be set in the range from 0° to 10° in 1° increments.

KSL cabinets are driven by two channels of the applicable d&b amplifier which provides dedicated processing functions for the front LF and passively crossed-over side LF and MF/HF sections.

All components are arranged symmetrically around the center axis of the cabinet to produce a perfectly symmetrical dispersion pattern. This setup allows for a very smooth crossover design with a well defined overlap of adjacent frequency bands resulting in a very consistent and accurate horizontal dispersion.

Due to the arrangement of the forward and sideward LF drivers in combination with their processing functions, the directivity is maintained across the entire frequency range.

The frequency response extends from 54 Hz to above 18 kHz.

The cabinet enclosures are constructed from marine plywood and have an impact and weather protected PCP (Polyurea Cabinet Protection) finish. The front and side panels of the cabinets incorporate a rigid metal grill backed by an acoustically transparent and water repellent fabric. Each side panel incorporates a handle while two additional handles are provided at the rear.

SL-Series rigging components and arrays

Cabinets are mechanically connected using the rigging strands on both sides of the cabinet front and a central strand at the rear of the cabinet. All necessary rigging components are mounted on the cabinet and fold out or slide out when needed.

A detailed description of the SL-Series rigging components is given in the SL-Series Rigging manual.

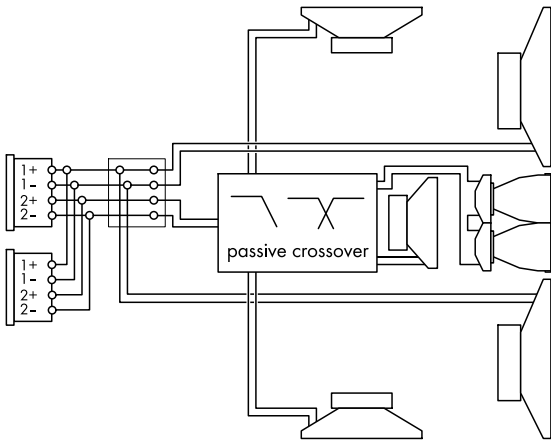

NLT4 F/M Connector wiring

Following the driver arrangement within the cabinet.

2.2 Connections

The cabinets are fitted with NLT4 F/M connectors. All four pins of both connectors are wired in parallel using the following pin assignment:

- Pins 1+/1- feeding the forward LF drivers.
- Pins 2+/2- are connected to the passive crossover networks feeding the side firing LF drivers and the MF/HF driver sections.

d&b LoadMatch

With the d&b four channel amplifier platform, the LoadMatch function enables the amplifier to electrically compensate for the properties of the loudspeaker cable used without the need for an additional sense wire. For applicable loudspeakers, LoadMatch is therefore independent of the connector type used.

2.3 Operation

Amplifier output mode(s): 2-Way Active		
Application	Setup	Cabinets per pair of amplifier channels
KSL8	KSL8 Line	2
	KSL8 Arc	2
	KSL8 AP	1
KSL12	KSL12 Line	2
	KSL12 Arc	2
	KSL12 AP	1

Line and Arc setups

The selection of "Line" or "Arc" depends on the curvature of the array. Both setups may be used within one array.

The "Line" setup is used for long throw array sections with three or more consecutive splay settings of 0°, 1° or 2°. Compared to the "Arc" setup, the "Line" setup considers the different cabinet interaction effects between straight and curved section of an array.

The Arc setup is intended for line array loudspeakers when used in curved array sections.

AP setup

In connection with d&b ArrayProcessing (AP), the AP setup contains the AP data that is generated by the ArrayCalc simulation software and transferred to the applicable amplifiers via the d&b Remote network (OCA/AES70) using R1.

As soon as the data has been sent to the amplifiers, the AP setup is automatically activated.

2.3.1 Controller settings

For acoustic adjustment the functions CUT, CPL and HFC can be selected.

CUT mode

Set to CUT, the low frequency level of the cabinets is reduced. The KSL8/KSL12 array is now configured for use with the actively driven d&b SL-SUB or SL-GSUB cabinets.

CPL function

The CPL (**C**oupling) function compensates for coupling effects between the cabinets by reducing the low and low-mid frequency level.

The SL-Series setups provide a two-stage filter (Low/Mid), which allows the independent shaping of the low and low-mid responses.

The characteristics of the CPL function are shown in the diagram opposite. The standard setting (0) maintains the default array response. CPL values can be set in the range from +5 to -5 (Low) and from 0 to -8 (Mid) in increments of 0.5.

Note: Please note that all cabinets within the array should be operated with the same CPL setting.

When processed conventionally (Line/Arc), the larger the array the more attenuation by CPL will be required to achieve a neutral response.

When operated with ArrayProcessing (AP), an array will automatically be provided with the system target response, as shown in the graphic opposite. All coupling effects caused by the array length and shape are considered in the AP data. The CPL function may still be used for additional corrections, for example of room properties or coupling effects between main hangs and outfills.

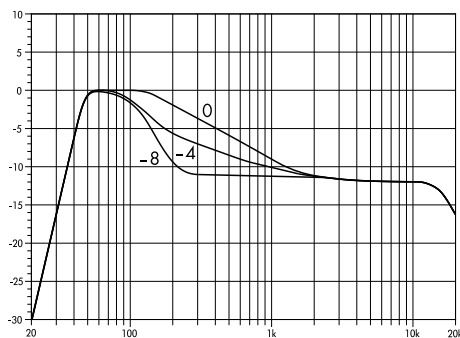
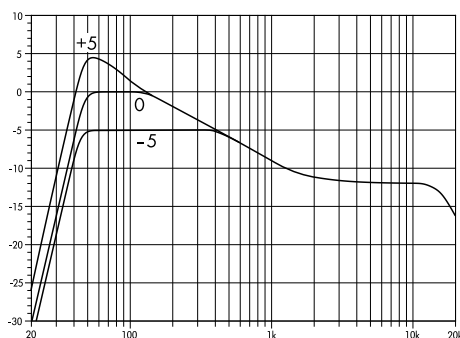

Frequency response correction of the CPL function for low and low-mid frequency level*

* schematic diagram

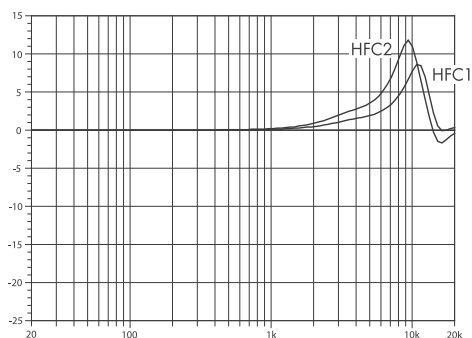

Frequency response correction of the HFC function*

* schematic diagram

HFC function (Line/Arc setups only)

Selecting the HFC (High Frequency Compensation) function compensates for the loss of high frequency energy due to air absorption when loudspeakers are used to cover far field listening positions.

The HFC function has two settings (HFC1 and HFC2) for different distances the cabinets need to cover. The settings should be used selectively; HFC1 compensates for 40 m (131 ft) and HFC2 for 80 m (262.5 ft) of additional distance from a reference position.

The compensation is adjusted for a typical relative humidity of 50 % at 22 °C. With lower humidity the absorption by air increases, therefore the distances where the respective HFC setting provides a correct equalization are shorter than indicated above.

Using the HFC function provides the correct sound balance between close and remote audience areas, whilst all amplifiers driving the array can be fed with the same signal.

2.4 Dispersion characteristics

The graphs below show the horizontal dispersion angle over frequency plotted using lines of equal sound pressure (isobars) at -6 dB and -12 dB. The nominal horizontal dispersion of 80°/120° is maintained above 150 Hz merging into a cardioid dispersion down to the lowest frequency.

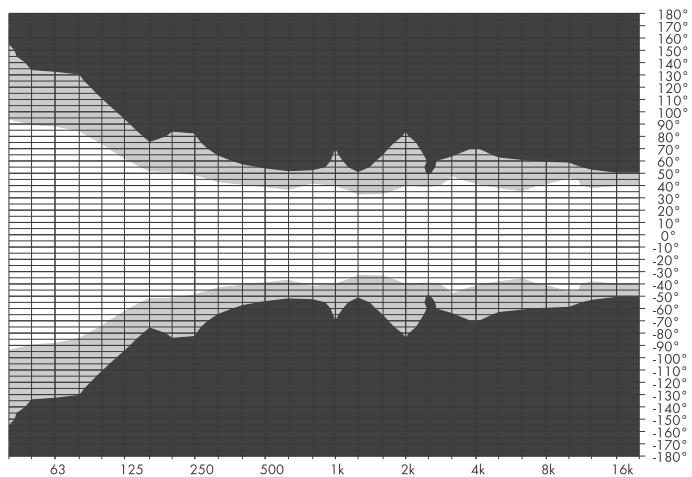

KSL8 isobar diagram horizontal

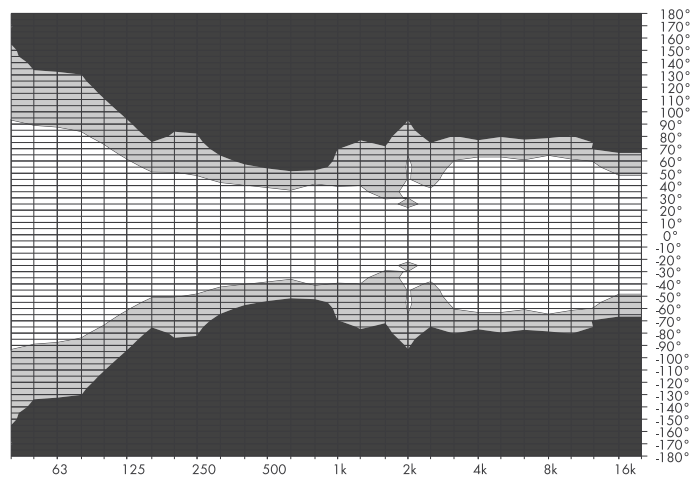

KSL12 isobar diagram horizontal

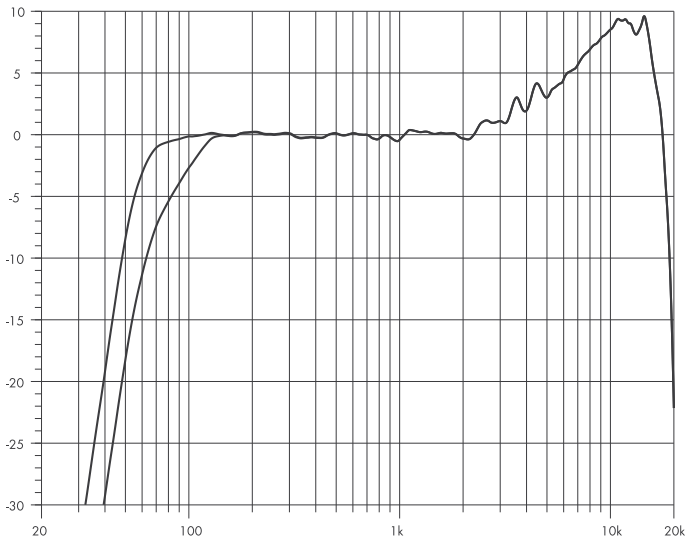

KSL8: Frequency response*, Standard and CUT modes

*single cabinet within array

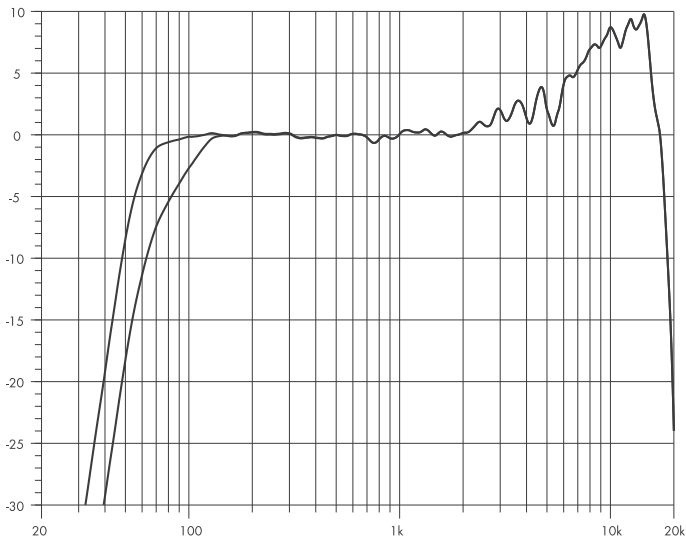

KSL12: Frequency response*, Standard and CUT modes

*single cabinet within array

2.5 Technical specifications

System data

Frequency response (-5 dB standard)	54 Hz - 18 kHz
Frequency response (-5 dB CUT mode)	75 Hz - 18 kHz
Max. sound pressure (1 m, free field)	
KSL8	145 dB
KSL12	144 dB
..... (SPLmax: Broadband signal IEC 60268)	

Loudspeaker data

Nominal impedance front LF	8 ohms
Nominal impedance side LF/MF/HF	8 ohms
Power handling capacity front LF (RMS/peak 10 ms)	
.....	450/1800 W
Power handling capacity side LF/MF/HF (RMS/peak 10 ms)	
.....	250/1000 W
Nominal dispersion angle (horizontal) KSL8/KSL12	80°/120°
Splay angle setting	0 ... 10° (1° increment)
Components	2 x 10" front LF driver
.....	2 x 8" side LF driver
.....	1 x 8" MF driver
.....	2 x 1.4" exit compression driver with 3" coil
.....	Passive crossover network
Connections	NLT4 F/M
Pin assignment	1+: Front LF+/1-: Front LF-
.....	2+: Side LF/MF/HF+/2-: Side LF/MF/HF-
Weight	58 kg (128 lb)

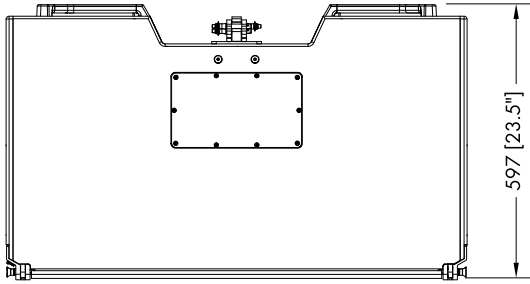
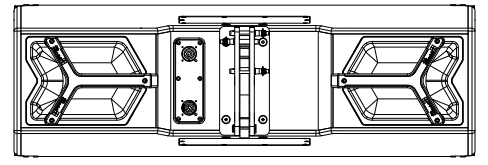
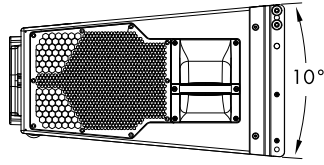
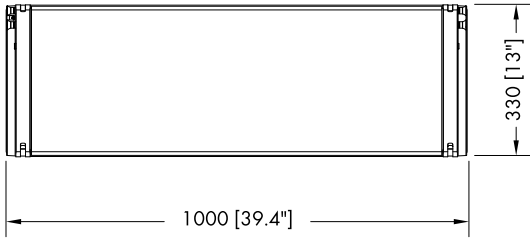

KSL8/KSL12 cabinet dimensions in mm [inch]



3.1 EU conformity of loudspeakers (CE symbol)

This declaration applies to:

d&b Z0780 KSL8 loudspeaker

d&b Z0781 KSL12 loudspeaker

manufactured by d&b audiotechnik GmbH & Co. KG.

All product variants are included, provided they correspond to the original technical version and have not been subject to any later design or electromechanical modifications.

We herewith declare that said products are in conformity with the provisions of the respective EC directives including all applicable amendments.

A detailed declaration is available on request and can be ordered from d&b or downloaded from the d&b website at www.dbaudio.com.

3.2 WEEE Declaration (Disposal)

Electrical and electronic equipment must be disposed of separately from normal waste at the end of its operational lifetime.

Please dispose of this product according to the respective national regulations or contractual agreements. If there are any further questions concerning the disposal of this product, please contact d&b audiotechnik.

WEEE-Reg.-Nr. DE: 13421928

