

**Vi-SUB**  
**Manual 1.2 en**

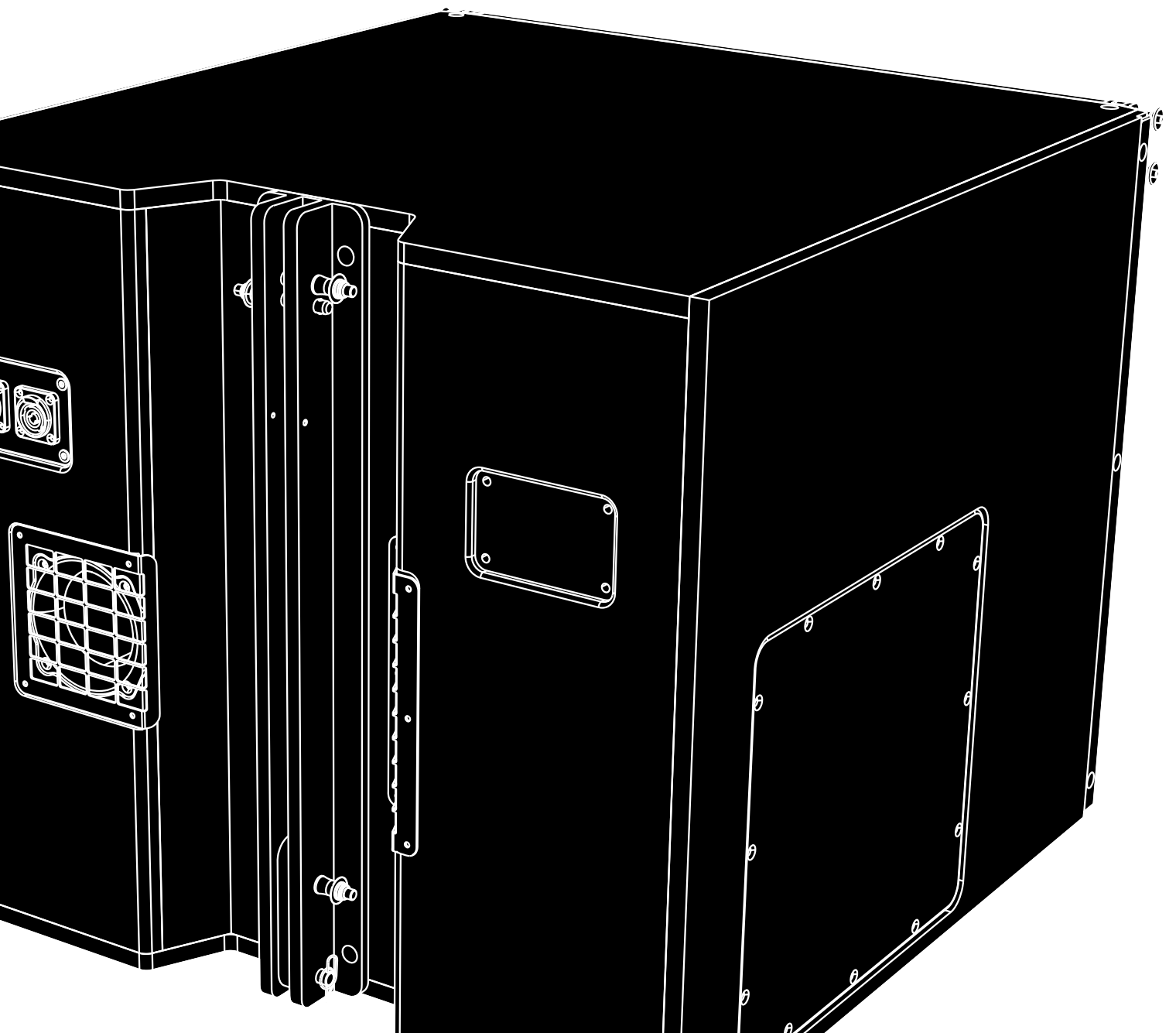

## **General information**

Vi-SUB Manual

Version: 1.2 en, 09/2015, D2707.EN .01

Copyright © 2015 by d&b audiotechnik GmbH; all rights reserved.

**Keep this manual with the product or in a safe place so that it is available for future reference.**

When reselling this product, hand over this manual to the new owner.

If you supply d&b products, please draw the attention of your customers to this manual. Enclose the relevant manuals with the systems. If you require additional manuals for this purpose, you can order them from d&b.

d&b audiotechnik GmbH  
Eugen-Adolff-Strasse 134, D-71522 Backnang, Germany  
T +49-7191-9669-0, F +49-7191-95 00 00  
docadmin@dbaudio.com, www.dbaudio.com

<b>1. Safety precautions</b> .....	<b>4</b>
1.1. Information regarding the use of loudspeakers.....	4
<b>2. Vi-SUB loudspeaker</b> .....	<b>5</b>
2.1. Product description.....	5
2.2. Connections.....	6
2.3. Operation.....	6
2.3.1. Controller settings.....	6
2.4. Technical specifications.....	7
<b>3. Manufacturer's Declarations</b> .....	<b>8</b>
3.1. EU conformity of loudspeakers (CE symbol).....	8
3.2. WEEE Declaration (Disposal).....	8

## 1.1. Information regarding the use of loudspeakers

### Potential risk of personal injury

Never stand in the immediate vicinity of loudspeakers driven at a high level. Professional loudspeaker systems are capable of causing a sound pressure level detrimental to human health. Seemingly non-critical sound levels (from approx. 95 dB SPL) can cause hearing damage if people are exposed to it over a long period.

In order to prevent accidents when deploying loudspeakers on the ground or when flown, please take note of the following:

- When setting up the loudspeakers or loudspeaker stands, make sure they are standing on a firm surface. If you place several systems on top of one another, use straps to secure them against movement.
- Only use accessories which have been tested and approved by d&b for assembly and mobile deployment. Pay attention to the correct application and maximum load capacity of the accessories as detailed in our specific "Mounting instructions" or in our "Flying system and Rigging manuals".
- Ensure that all additional hardware, fixings and fasteners used for installation or mobile deployment are of an appropriate size and load safety factor. Pay attention to the manufacturers' instructions and to the relevant safety guidelines.
- Regularly check the loudspeaker housings and accessories for visible signs of wear and tear, and replace them when necessary.
- Regularly check all load bearing bolts in the mounting devices.

### Potential risk of material damage

Loudspeakers produce a static magnetic field even if they are not connected or are not in use. Therefore make sure when erecting and transporting loudspeakers that they are nowhere near equipment and objects which may be impaired or damaged by an external magnetic field. Generally speaking, a distance of 0.5 m (1.5 ft) from magnetic data carriers (floppy disks, audio and video tapes, bank cards, etc.) is sufficient; a distance of more than 1 m (3 ft) may be necessary with computer and video monitors.

## 2. Vi-SUB loudspeaker

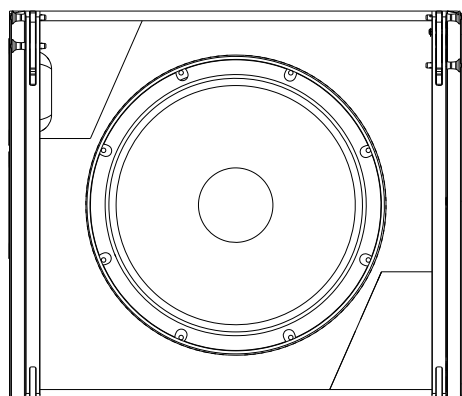

Fig. 1: Vi-SUB loudspeaker

### 2.1. Product description

The Vi-SUB is a compact high performance cardioid subwoofer for use with d&b Vi-TOP cabinets.

The Vi-SUB houses two long excursion neodymium drivers in an integrated cardioid setup: a 18" driver in a bass-reflex design facing to the front and a 12" driver in a two chamber bandpass design radiating to the rear. The arrangement and tuning provide a cardioid dispersion pattern using a single amplifier channel.

Its frequency response extends from 37 Hz to 115/95 Hz.

The cabinet is constructed from marine plywood and has an impact and weather protected PCP (Polyurea Cabinet Protection) finish. The front of the loudspeaker cabinet is protected by a rigid metal grill backed by an acoustically transparent foam.

### Cabinet options

The WR option enables operation of loudspeakers in changing ambient conditions, however it is not intended to enable permanent, unprotected operation of loudspeakers outdoors.

- Provide an additional cover over the entire loudspeakers/array.

### Vi rigging components and arrays

Cabinets are mechanically connected using the rigging strands on both sides of the cabinet front and a central strand at the rear of the cabinet. All necessary rigging components are mounted to the cabinet and fold out or slide out when needed. The rigging components are also intended to interconnect and secure Vi-SUB cabinets in ground stack applications.

A detailed description of the Vi rigging components is given in the Vi Rigging manual which is provided with the Z5387.xxx Mounting frames.

A detailed description of planning and designing V arrays is given in the technical information "TI 385 d&b Line array design, ArrayCalc" which is provided with the V Flying frame.

The d&b ArrayCalc array calculator can be downloaded from the d&b website at [www.dbaudio.com](http://www.dbaudio.com).

### Cardioid dispersion

Cardioid dispersion avoids unwanted energy behind the system and greatly reduces the reverberant field at low frequencies providing highest accuracy in low frequency reproduction. The subwoofers can be used as stand-alone solutions or in stacked combinations with a minimum distance of 60 cm (2 ft) between adjacent cabinets or between the cabinets and a side wall. When set up in front of walls, the minimum distance to rear walls should be 30 cm (1 ft).

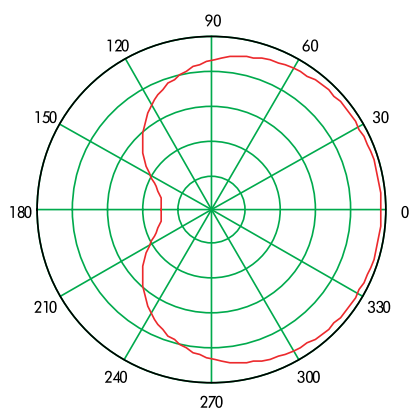
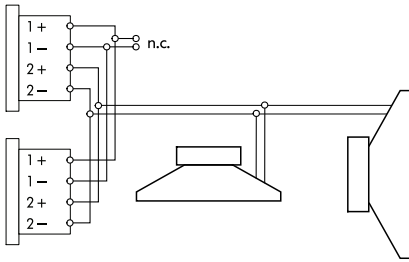

Fig. 2: Cardioid dispersion pattern



**Fig. 3: Connector wiring**

## 2.2. Connections

The cabinet is fitted with a pair of 4-pin connectors. All four pins of both connectors are wired in parallel. The Vi-SUB uses the pin assignments 2+/2-. Pins 1+/1- are designated to the Vi8 or Vi12 loudspeakers. Using one connector as the input, the second connector allows for direct connection to a second cabinet.

Cabinets with the weather resistant option (WR) are equipped with a fixed input cable (PG type, H07-RN-F, 2 x 2.5 mm<sup>2</sup> (AWG 13), standard length 5.5 m (18 ft).

Pin equivalents of the applicable connector options are listed in the table below.

<b>NL4</b>	1+	1-	2+	2-
<b>PG</b>	n.a.	n.a.	Brown (+)	Blue (-)

## 2.3. Operation

### NOTICE!

Only operate d&b loudspeakers with a correctly configured d&b amplifier, otherwise there is a risk of damaging the loudspeaker components.

Select the controller setup V-SUB.

Within the amplifiers (except for D6) it is available in Dual Channel or Mix TOP/SUB mode.

Up to two Vi-SUB loudspeakers can be driven by the respective amplifier channel.

### 2.3.1. Controller settings

For acoustic adjustment the 100 Hz function can be selected.

#### 100 Hz circuit

If the 100 Hz circuit is selected, the upper operating frequency of the system is reduced from 115 Hz to 95 Hz.

It can be used when actively driven Vi subwoofers are used to supplement Vi cabinets operated in full range mode. The 100 Hz mode can also be used to compensate for the effect of close coupling between the Vi-SUB and Vi cabinets operated in CUT mode. With Ti cabinets the standard mode is recommended.

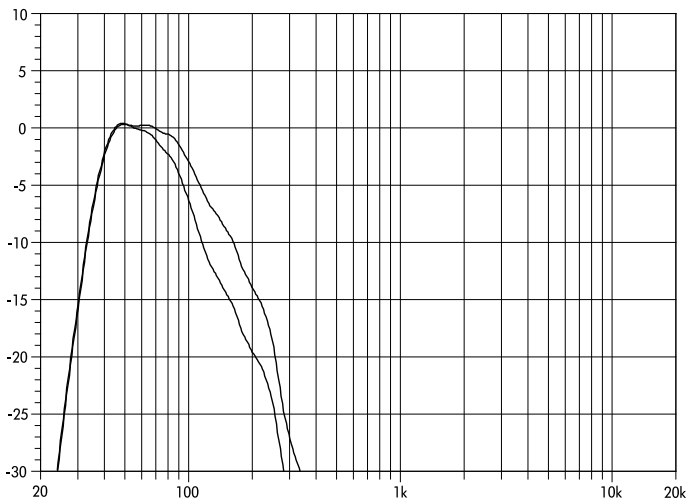

**Fig. 4: Vi-SUB frequency response, standard and 100 Hz mode**

## 2.4. Technical specifications

### Vi-SUB system data

Frequency response (-5 dB standard) .....	37 Hz - 115 Hz
Frequency response (-5 dB 100 Hz mode) .....	37 Hz - 95 Hz
Max. sound pressure (1 m, free field) .....	.....
with D12/D20/30D .....	133 dB
with D80 .....	137 dB
.....(SPLmax peak, pink noise test signal with crest factor of 4)	

### Vi-SUB loudspeaker

Nominal impedance .....	8 ohms
Power handling capacity (RMS/peak 10 ms) .....	800/3200 W
Components .....	1 x 18" driver
.....	1 x 12" driver
Connections .....	2 x NL4 M
Optional fixed cable (PG): .....	.....
.....	H07-RN-F, 2 x 2.5 mm <sup>2</sup> (AWG 13), 5.5 m (18 ft)
Pin assignment .....	NL4 M: 2+ / 2-
.....	Fixed cable (PG): brown + / blue -
Weight .....	62 kg (137 lb)

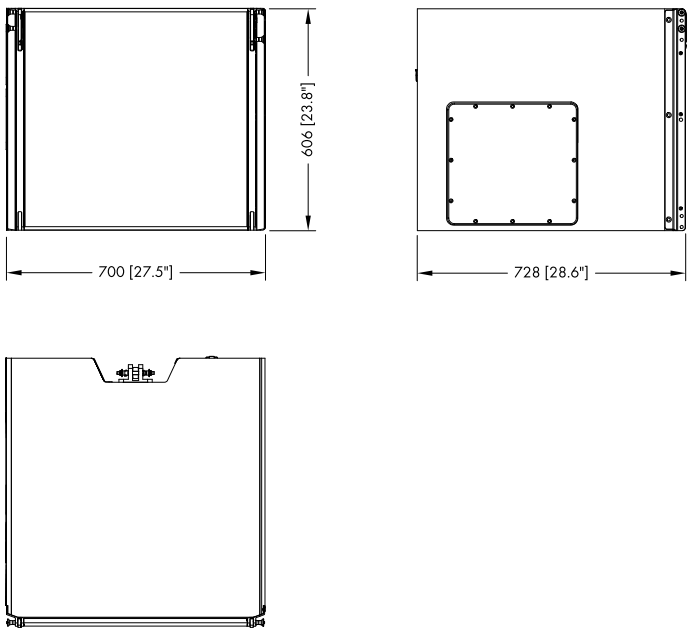

**Fig. 5: Vi-SUB cabinet dimensions in mm [inch]**

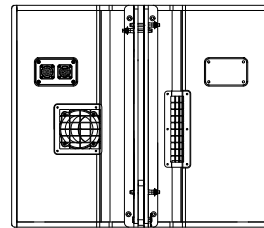



### 3.1. EU conformity of loudspeakers (CE symbol)

This declaration applies to:

#### **d&b Vi-SUB loudspeaker, Z0538**

manufactured by d&b audiotechnik GmbH.

All production versions of these types are included, provided they correspond to the original technical version and have not been subject to any later design or electromechanical modifications.

We herewith declare that said products are in conformity with the provisions of the respective EC directives including all applicable amendments.

A detailed declaration is available on request and can be ordered from d&b or downloaded from the d&b website at [www.dbaudio.com](http://www.dbaudio.com).

### 3.2. WEEE Declaration (Disposal)

Electrical and electronic equipment must be disposed of separately from normal waste at the end of its operational lifetime.

Please dispose of this product according to the respective national regulations or contractual agreements. If there are any further questions concerning the disposal of this product, please contact d&b audiotechnik.





